

# Specification

# Image



# HP

Series  
40 pound  
60 pound  
100 pound  
135 pound

# Washer Extractor



ភី អេស អេស អេស ខ្សែលីមីត  
PHS ASIA Co., Ltd



MODEL	Metric	US	HP - 40	HP - 60	HP - 100	HP - 135
<b>CAPACITY :</b>						
Loading factor	1 : 10		18.7(41)	27.4 (60)	47.8 (105)	61.2 (135)
	1 : 12	kg lbs	15.6 (34.3)	22.8 (50.2)	39.8 (87.6)	51.1 (112.7)
	1 : 13	kg lbs	14.4 (31.7)	21.1 (46.4)	36.8 (81)	47 (103.8)
<b>OVERALL DIMENSIONS :</b>						
Width	mm	in	838 (33)	880 (34.6)	1049 (41.3)	1334 (52.5)
Height	mm	in	1397 (55)	1670 (65.8)	1753 (69)	1854 (73)
Depth	mm	in	1143 (45)	1210 (47.6)	1422 (56)	1524 (60)
<b>WEIGHT AND SHIPPING INFORMATION :</b>						
Net weight	kg	lbs	480 (1055)	660 (1450)	801 (1763)	1082 (2380)
Domestic shipping weight	kg	lbs	492 (1083)	720 (1584)	823 (1810)	1106 (2433)
<b>CYLINDER INFORMATION :</b>						
Diameter	mm	in	680 (26.8)	790 (31.1)	940 (37)	1092 (43)
Depth	mm	in	515 (20.3)	560 (22)	690 (27.7)	635 (25)
Volume	liter	cu ft	187 (6.6)	274 (9.7)	478 (16.9)	595 (21)
Perforation size	mm	in	4.8 (0.188)	4.8 (0.188)	4.8 (0.188)	4.8 (0.188)
Perforation open area	%	%	19 (19)	23 (23)	24 (24)	24 (24)
<b>CYLINDER SPEEDS (Programmable) :</b>						
Wash	rpm	g	46 (0.8)	43 (0.8)	39.5 (0.8)	36 (0.8)
Distribution	rpm	g	73 (2)	67 (2)	62 (2)	57 (2)
Intermediate extraction	rpm	g	629 (150)	583 (150)	540 (150)	495 (150)
High extract 1	rpm	g	725 (200)	673 (200)	624 (200)	572 (200)
High extract 2	rpm	g	811 (250)	753 (250)	698 (250)	640 (250)
High extract 3	rpm	g	960 (300)	825 (300)	755 (300)	700 (300)
<b>DOOR OPENING AND HEIGHT :</b>						
Diameter	mm	in	400 (15.7)	450 (17.7)	508 (20)	508 (20)
Height of door bottom above floor	mm	in	355 (14)	569 (22.4)	635 (25)	737 (29)
<b>DRIVE INFORMATION :</b>						
Number of motors	Number		1	1	1	1
Size of motor	KW Hp		2.2 (3)	3.7 (5)	5.5 (7.5)	7.5 (10)
<b>WATER INLETS AND CONSUMPTION :</b>						
Hot water size	DN	in	20 (3/4)	20 (3/4)	25 (1)	25 (1)
Cold water size	DN	in	20 (3/4)	20 (3/4)	25 (1)	25 (1)
Additional water Inlet	DN	in	20 (3/4)	20 (3/4)	25 (1)	25 (1)
Average HOT water consumption/ cycle	liters gal		193 (51)	223 (59)	371 (98)	371 (98)
Average COLD water consumption/ cycle	liters gal		102 (27)	106 (28)	174 (46)	174 (46)
<b>DRAIN OUTLETS AND CAPACITY :</b>						
Number of drains standard	Number		1	1	1	1
Number of drains optional (water re-use)	Number		1	1	1	1
Drain size	mm in		76.2 (3)	76.2 (3)	76.2 (3)	76.2 (3)
Drain capacity	liter/min gpm		159 (42)	246 (65)	473 (125)	473 (125)
<b>STEAM INLET AND CONSUMPTION :</b>						
Steam inlet size	DN	in	13 (1/2)	13 (1/2)	20 (3/4)	20 (3/4)
Required steam to heat bath 10F (5.55C) LOW	kg lbs		5.3 (2.4)	8.4 (3.8)	14 (6.4)	14 (6.4)
Required steam to heat bath 10F (5.55C) HIGH	kg lbs		6.6 (3)	9.2 (4.2)	16 (7.3)	16 (7.3)
Average steam consumption per cycle	kg BHP		23 (1.5)	35 (2.2)	60 (3.6)	60 (3.6)

## Standard Features :

- All wetted parts are 304 (18/8) Stainless steel
- 1 compartment supply dispenser
- 6 external liquid supply connections
- Advanced microprocessor
- 300G extract force
- 5 degree lean back for strenght and easy loading
- Built in vacuum breaker
- Variable frequency drive
- Stainless steel cabinet
- Fits through 36-inch door
- Single motor drive
- Cool down
- Water reuse capable

## Optional Features :

- Direct steam heating
- Electrical heating
- 5 compartment dispenser
- Water reuse drain and inlet
- EMI filter for CE
- PC programming kit

Specification and Design subject to change without notice  
Additional options : Consult factory or distributor

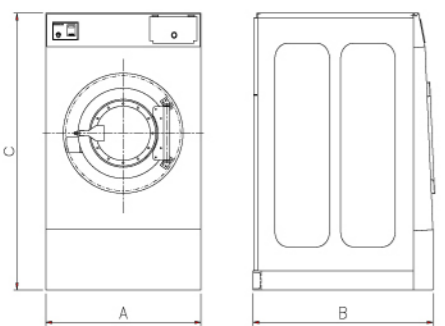

CONTACT: Mr. SOK PISETH  
PHONE: 081 44 22 03 / 085 666 184  
EMAIL piseth@phsasia.com.kh  
Siem Reap: #S1033, S1034, S1035 Borey Teschor, Kork Tnaot Village, Kandek Commune, Prasat Bakong District, Siem Reap Province.  
Phnom Penh: #19, St.16 Borey Piphub Thmey Toulasangke, Russey Keo, Cambodia

# Image HP Series - *HARDMOUNT*

## Professional High Speed Economy Washer - Extractors

The Image HP series - Hardmount High-Speed Washer-Extractors for demanding Small to Medium Size On-Premises Laundry Applications including Health Care, Hospitality, Drycleaners/Wet Cleaning

Professional Performance, Flexibility and Energy efficiency. A Competitive and Affordable Investment Alternative

The HP Series is designed to be an alternative to the commonly used high-speed Hardmount machines in the market. This series of machines has the cabinet and all parts in connection with the wash solution made of 304 stainless steel. The robust design ensures low cost of ownership and infrequent maintenance. Experienced engineering makes the HP Series has advanced features that make the machine suitable for wet cleaning, water reuse systems and operations with ozone systems. Our combined engineering expertise plus an outstanding warranty assures that you will receive the best for less and equipment that will meet today's and tomorrow's need in the laundry industry.

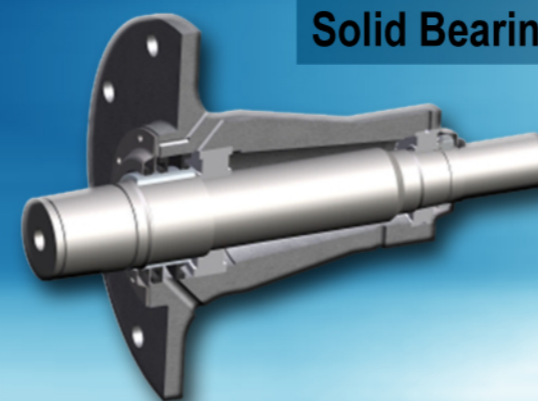

### Solid Bearing Housing

Rugged cast iron construction is used in our single durable bearing housing. The single bearing housing increases the structural integrity and provides for longer bearing and seal life. The revolutionary CARB torroidal SKF bearing used in the machine is the ultimate long life solution for high-speed washers that the industry has been searching for. The shaft is made of high tensile strength steel that meets the high standards use for load calculation of bearings and shaft. Two double lip seals and face seals protect the bearings. The seals as well as the bearings can be greased manually yielding longer life. The machines have provision for easy installation of automatic lubricators. Should the seals leak, the main bearings will not be damaged, thanks to an extra large leak off area in the bearing housing. A large leak off area is the answer to long bearing life, as water can not enter the bearings.

### Powerful Advanced Computer Control Center

The advanced EL 6 electronic control center is easy to use and has the features needed for maximum productivity and lowest cost of operation. The microprocessor controls the temperatures, water levels, speeds and maintenance intervals. A thermal cool down is programmable that will ensure optimal performance for any garments that require special wrinkle control and other special treatments. It can be programmed both individual and with a PC. It can also be used with a memory card that significantly simplifies the programming at installation. The EL 6 can be programmed to display in five languages and keep track of operation times, number of cycles and maintenance. It has features for programming any wash activity to meet today and tomorrow's demand for water treatment of textile fiber and garments. It is the most flexible control yet developed for the stand-alone commercial and industrial washers in the industry and has proven track record for reliability.



### Robust Energy Efficient Drive

The machine is provided with a single totally enclosed standard motor that is controlled electronically by a variable frequency drive. This makes the machine control simple and very flexible. The inverter reduces the peak energy demand, saves energy and lowers the inrush current. It also acts as a watchdog for the motor, protecting against overload and over voltage. The single motor drive and inverter eliminates clutches, gear reducers, idlers and reduces the use of electromechanical components such as contactors and relays. It provides a powerful yet simple drive alternative that is more economical than 2-speed motors. The inverter makes it possible to achieve higher extract speeds that achieve significant energy and time saving in the drying process.



### Spray Rinse Capability as Standard

The HP models are provided with an effective through the door spray rinse system that reduces the rinse time and saves water. During a rinse step, water is sprayed through the linen during a slow extraction. This allows the water to drain immediately rather than using traditional bath rinse that might consume more water and take longer. The system has a high flow rate that makes the spray rinse more effective. Large non-restricted water valves are used for cold and hot water, filling the machine quickly and accurately to the water level programmed in the microprocessor.

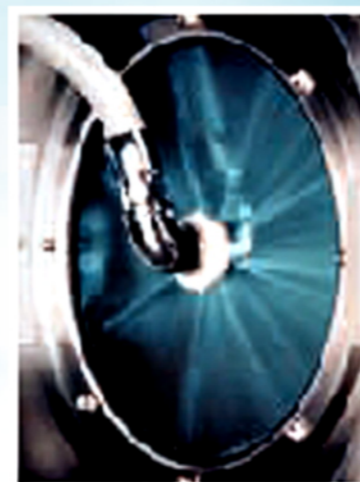

### High Speeds save Energy, Time and Money

A factor that can significantly affect the operational productivity in a laundry is the machine's extraction speed. A machine with a G-force of 300G will save a significant amount of energy and time in the drying process compared to a low speed 80G machine, as more water is extracted from the load during the extraction cycle. In fact the energy and time saving can pay for the cost of the equipment! Your dryers would not work overtime, either. Goods can be taken straight from the washer-extractor to an ironer or finisher without slowing down the productivity. The high speed or G-force is the driving factor. By utilizing the inverter technology it is possible to achieve this high-speed extraction in a solid mounted machine. The inverter automatically measures the out of balance electronically and decides if the machine can proceed to high speed and G-force.

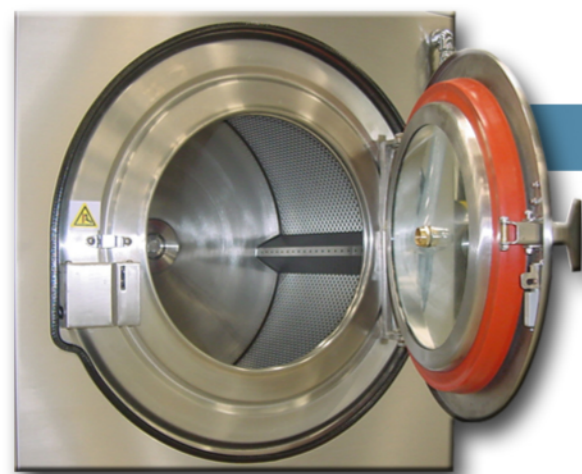
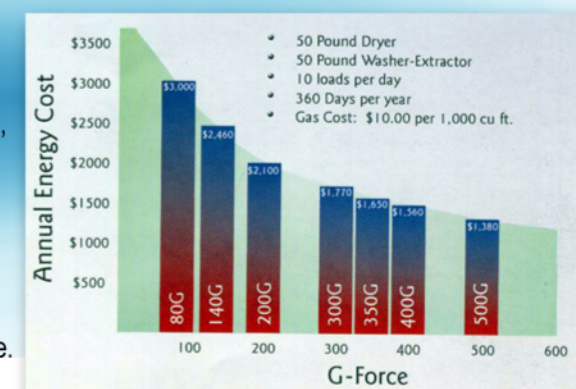

### Large Door Opening and Safe Door Interlock

Loading and unloading are fast and easy through the oversized door that opens 180 degrees away from laundry carts. The door is located at a convenient height for laundry carts. The door is constructed of stainless steel and built with an oversize stainless steel hinge for extra strength and durability. The silicon door gasket is designed for long life and seals to the shell every time without leaking. A powerful and safe electro-mechanical door interlocking system is provided for safe and easy operation.

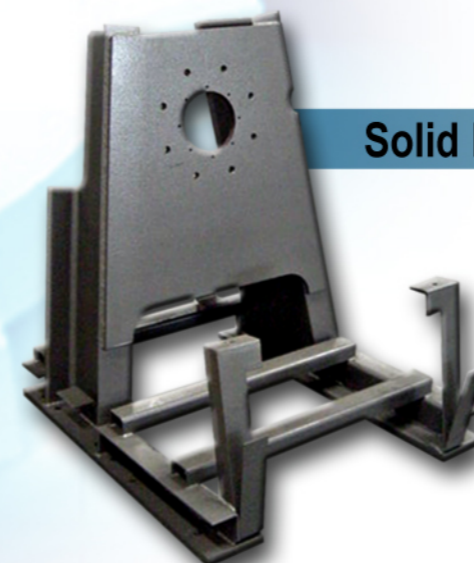

### Solid Mount Construction

Amazing strength and fewer parts give the HP series extra long life, without needless breakdowns. The frame is engineered, computer analyzed, and tested to ensure for a lifetime of rigorous operation. It has a protective powder coating to reduce possible corrosion and prolong the life.

